



**CanaLUX<sup>®</sup>**  
CABLE TRUNKING SYSTEMS



**2017 - 2018**  
**PRODUCT CATALOGUE**

# CERTIFICATE

**EC DECLARATION OF CONFORMITY**

Manufacturer: SC ELECTRO STAR SRL, with main location in Saftica, str. Biserica sf Troita, nr. 3, jud. Ilfov, Romania, phone +40213130486, fax: +02136774945, e-mail: office@canalux.ro, VAT number RO 19178050 si registered under number J23/2253/2006

Product: cable trunking systems and cable ducting systems for electrical installations

Type, description: see the Appendix; date of manufacture is written on each product.

Harmonized standards:

- SR EN 50085-1:2006 Cable trunking systems and cable ducting systems for electrical installations -- Part 1: General requirements.
- SR EN 50085-2-1:2007 Cable trunking systems and cable ducting systems for electrical installations -- Part 2-1: Cable trunking systems and cable ducting systems intended for mounting on walls and ceilings.
- SR EN 50085-2-1:2007/A1:2012 Cable trunking systems and cable ducting systems for electrical installations -- Part 2-1: Cable trunking systems and cable ducting systems intended for mounting on walls and ceilings.
- SR EN 50085-2-2:2009 Cable trunking systems and cable ducting systems for electrical installations -- Part 2-2: Particular requirements for cable trunking systems and cable ducting systems intended for mounting underfloor, flushfloor, or onfloor.
- SR EN 50085-2-4:2010 Cable trunking systems and cable ducting systems for electrical installations -- Part 2-4: Particular requirements for service poles and service posts.
- SR EN 50085-2-3:2011 Cable trunking systems and cable ducting systems for electrical installations -- Part 2-3: Particular requirements for slotted cable trunking systems intended for installation in cabinets.

Support documentation reference: ST1/2013

The last two digits of the year in which the CE mark was affixed: 13

Issued at Saftica, Romania, on 28 August 2015

Authorized person  
Abdullatif Eminet  
Administrator



**ICPE**  
ELECTRIC PRODUCTS CERTIFICATION  
INDEPENDENT BODY  
ICPE - ORGANISM INDEPENDENT  
PENTRU CERTIFICAREA PRODUSORILOR ELECTRICE  
M02946/24 03 2009

Sediu: Limbii 913, Corp M-1, D3-14, 030146, Bucuresti, Romania  
Telefon: 021 598 33 00; 021 598 33 49  
Fax: 021 346 40 35; 021 598 33 19  
www.icpe.ro

normă aplicată pentru  
CERTIFICARE  
SR EN 50085-1:2006+2011  
CERTIFICAT DE ACREDITARE  
FR 03

**CERTIFICAT DE CONFORMITATE**  
Certificate of Conformity

Certificat nr: Certificate No:	670	Data emiterii: Date of issue: (day/month/year)	08.12.2015	Statut: Status:	Initial	Exemplar nr.: Copy No:	3/4
Număr dosar certificare: Certification file No:	400/1	Contract General nr.: General Agreement No.:	64/2015	Pagina Page	1/8		
Titular certificat (nume și adresă): Certificate holder (name and address): <b>ELECTRO STAR SRL</b> Femei 56A street, village Saftica, comuna Balotesti, county Ilfov, Romania							
Domeniul de aplicare: Application range: Cable Management Systems							
Denumirea produsului: Product name: PVC CABLE TRUNKING SYSTEMS							
Tip/model de referință (seria): Reference type/model (series): CNL-F/C-40040							
Varianta(e) (seria): Variant(s) (series): Batch 532111.2015							
Marca comercială înregistrată: Registered Trade Mark: CANALUX							
Producător (nume și adresă): Manufacturer (name and address): ELECTRO STAR SRL							
Locul de producție (nume și adresă): Manufacturing location (name and address): ELECTRO STAR SRL							
Standard național sau alt normativ utilizat pentru certificare: National standard or other normative document used as reference for certification: SR EN 50085-1:2006+A1:2014 SR EN 50085-2-1:2007+A1:2012							
Raport de încercări (nr. idata): Test Report (No. Idata): According to Annex							
Certificatul este valabil până la data: The certificate is valid until: (day/month/year) 07.12.2017							

In baza rezultatelor încercărilor efectuate, se declară că produsul este în conformitate cu standardul(ile) menționat(ă) mai sus.  
Based on the results of the performed tests, the product is declared to be in compliance with the above standard(s).

Schema de certificare utilizată este «1a» (certificarea conformității pe bază de încercări de tip). Produsele de același tip fabricate ulterior nu sunt acoperite de acest certificat de conformitate.  
The certification scheme used is «1a» (conformity certification based on type tests). This certificate is valid only for the sample underwent to the type test. Subsequent production items are not covered by this certificate of conformity.

Acest certificat și anexa sa pot fi reproduse numai în întregime.  
This certificate and its annex may only be reproduced in full.

Acest certificat nu este transferabil și rămâne proprietatea organismului emitent.  
This certificate is not transferable and remains the property of the issuing body.

Statutul și autenticitatea acestui certificat poate fi verificată pe site-ul [www.icpe.ro](http://www.icpe.ro)  
The Status and authenticity of this certificate may be verified by visiting site [www.icpe.ro](http://www.icpe.ro)

DIRECTOR TEHNIC ICPE  
ICPE TECHNICAL DIRECTOR  
Eng. Ecaterina Fransa

ICPE Cod F-11/R

Ediția din 24.11.2014



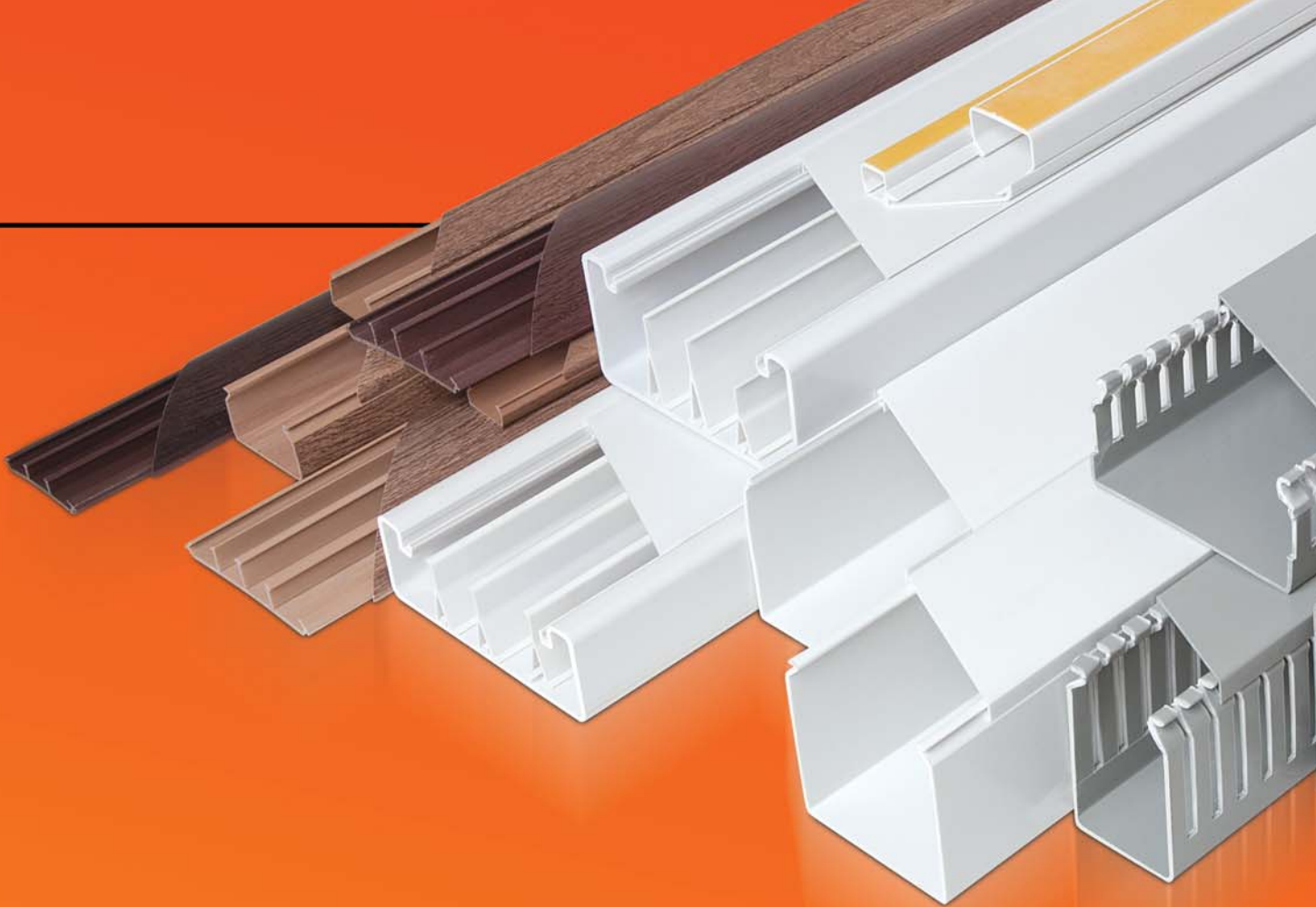

## ICONS - LEGEND



Material



Temperature resistance, scope of application (°C)



Flaming loop test (°C)



Fire reaction class of underlying material



Self - Snuffing



Products manufactured from leadless material



Impact strength (J)  
very low = 0,5 J; low = 1 J; medium = 2



Inside area (mm<sup>2</sup>)



Level of protection - IP classification



Mechanical protection



# CABLE TRUNKING SYSTEMS



## 10 x 8

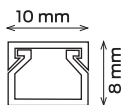

Product Code	<b>CNL-F-10008</b>	<b>CNL-C-10008</b>
Package	<b>Nylon</b>	<b>Box</b>
Lenght	<b>2 m</b>	<b>2 m</b>
Size	<b>10 x 8</b>	<b>10 x 8</b>
Package total (m)	<b>240 m</b>	<b>330 m</b>
Weight (kg)	<b>10.91 kg</b>	<b>15.80 kg</b>
Volume (m <sup>3</sup> )	<b>0.0291 m<sup>3</sup></b>	<b>0.0315 m<sup>3</sup></b>



## 12 x 12

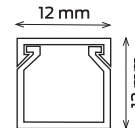

Product Code	<b>CNL-F-12012</b>	<b>CNL-C-12012</b>
Package	<b>Nylon</b>	<b>Box</b>
Lenght	<b>2 m</b>	<b>2 m</b>
Size	<b>12 x 12</b>	<b>12 x 12</b>
Package total (m)	<b>200 m</b>	<b>180 m</b>
Weight (kg)	<b>12.11 kg</b>	<b>11.75 kg</b>
Volume (m <sup>3</sup> )	<b>0.0341 m<sup>3</sup></b>	<b>0.0315 m<sup>3</sup></b>



## 15 x 10

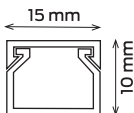

Product Code	<b>CNL-F-15010</b>	<b>CNL-C-15010</b>
Package	<b>Nylon</b>	<b>Box</b>
Lenght	<b>2 m</b>	<b>2 m</b>
Size	<b>15 x 10</b>	<b>15 x 10</b>
Package total (m)	<b>200 m</b>	<b>192 m</b>
Weight (kg)	<b>12.11 kg</b>	<b>12.47 kg</b>
Volume (m <sup>3</sup> )	<b>0.0360 m<sup>3</sup></b>	<b>0.0315 m<sup>3</sup></b>



## 16 x 16

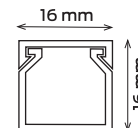

Product Code	<b>CNL-F-16016</b>	<b>CNL-C-16016</b>
Package	<b>Nylon</b>	<b>Box</b>
Lenght	<b>2 m</b>	<b>2 m</b>
Size	<b>16 x 16</b>	<b>16 x 16</b>
Package total (m)	<b>100 m</b>	<b>224 m</b>
Weight (kg)	<b>9.11 kg</b>	<b>21.11 kg</b>
Volume (m <sup>3</sup> )	<b>0.0309 m<sup>3</sup></b>	<b>0.0630 m<sup>3</sup></b>

# CABLE TRUNKING SYSTEMS



## 20 x 10

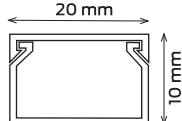

Product Code	<b>CNL-F-20010</b>	<b>CNL-C-20010</b>
Package	<b>Nylon</b>	<b>Box</b>
Lenght	<b>2 m</b>	<b>2 m</b>
Size	<b>20 x 10</b>	<b>20 x 10</b>
Package total (m)	<b>200 m</b>	<b>144 m</b>
Weight (kg)	<b>17.11 kg</b>	<b>13.19 kg</b>
Volume (m <sup>3</sup> )	<b>0.0476 m<sup>3</sup></b>	<b>0.315 m<sup>3</sup></b>



## 25 x 16

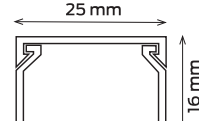

Product Code	<b>CNL-F-25016</b>	<b>CNL-C-25016</b>
Package	<b>Nylon</b>	<b>Box</b>
Lenght	<b>2 m</b>	<b>2 m</b>
Size	<b>25 x 16</b>	<b>25 x 16</b>
Package total (m)	<b>100 m</b>	<b>140 m</b>
Weight (kg)	<b>12.11 kg</b>	<b>17.75 kg</b>
Volume (m <sup>3</sup> )	<b>0.0464 m<sup>3</sup></b>	<b>0.0630 m<sup>3</sup></b>



## 25 x 25

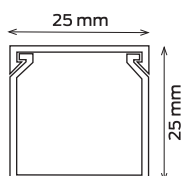

Product Code	<b>CNL-F-25025</b>	<b>CNL-C-25025</b>
Package	<b>Nylon</b>	<b>Box</b>
Lenght	<b>2 m</b>	<b>2 m</b>
Size	<b>25 x 25</b>	<b>25 x 25</b>
Package total (m)	<b>50 m</b>	<b>90 m</b>
Weight (kg)	<b>8.61 kg</b>	<b>16.25 kg</b>
Volume (m <sup>3</sup> )	<b>0.0368 m<sup>3</sup></b>	<b>0.0630 m<sup>3</sup></b>



## 30 x 20

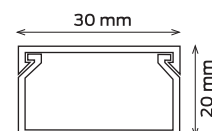

Product Code	<b>CNL-F-30020</b>	<b>CNL-C-30020</b>
Package	<b>Nylon</b>	<b>Box</b>
Lenght	<b>2 m</b>	<b>2 m</b>
Size	<b>30 x 20</b>	<b>30 x 20</b>
Package total (m)	<b>50 m</b>	<b>96 m</b>
Weight (kg)	<b>9.61 kg</b>	<b>16.31 kg</b>
Volume (m <sup>3</sup> )	<b>0.0344 m<sup>3</sup></b>	<b>0.0630 m<sup>3</sup></b>

# CABLE TRUNKING SYSTEMS



## 40 x 16

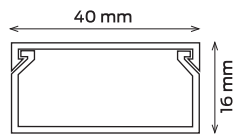

Product Code	CNL-F-40016	CNL-F-40016
Package	Nylon	Box
Lenght	2 m	2 m
Size	40 x 16	40 x 16
Package total (m)	60 m	128 m
Weight (kg)	11.51 kg	25.27 kg
Volume (m <sup>3</sup> )	0.0467 m <sup>3</sup>	0.0893 m <sup>3</sup>



## 40 x 25

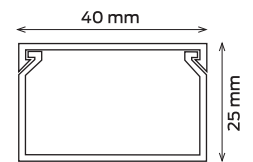

Product Code	CNL-F-40025	CNL-C-40025
Package	Nylon	Box
Lenght	2 m	2 m
Size	40 x 25	40 x 25
Package total (m)	40 m	80 m
Weight (kg)	8.71 kg	17.75 kg
Volume (m <sup>3</sup> )	0.0446 m <sup>3</sup>	0.0893 m <sup>3</sup>



## 40 x 40

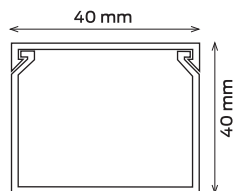

Product Code	CNL-F-40040	CNL-C-40040
Package	Nylon	Box
Lenght	2 m	2 m
Size	40 x 40	40 x 40
Package total (m)	36 m	72 m
Weight (kg)	10.91 kg	22.55 kg
Volume (m <sup>3</sup> )	0.0381 m <sup>3</sup>	0.1213 m <sup>3</sup>



## 60 x 40

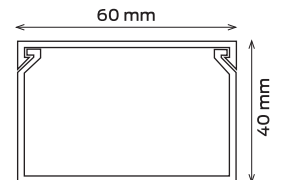

Product Code	CNL-F-60040	CNL-C-60040
Package	Nylon	Box
Lenght	2 m	2 m
Size	60 x 40	60 x 40
Package total (m)	24 m	48 m
Weight (kg)	10.31 kg	21.35 kg
Volume (m <sup>3</sup> )	0.0368 m <sup>3</sup>	0.1213 m <sup>3</sup>

# CABLE TRUNKING SYSTEMS



## 60 x 60

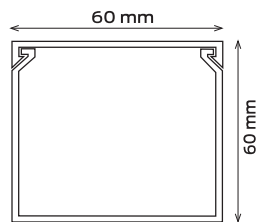

Product Code	<b>CNL-F-60060</b>	<b>CNL-C-60060</b>
Package	<b>Nylon</b>	<b>Box</b>
Length	<b>2 m</b>	<b>2 m</b>
Size	<b>60 x 60</b>	<b>60 x 60</b>
Package total (m)	<b>16 m</b>	<b>32 m</b>
Weight (kg)	<b>9.07 kg</b>	<b>18.87 kg</b>
Volume (m <sup>3</sup> )	<b>0.0368 m<sup>3</sup></b>	<b>0.1213 m<sup>3</sup></b>



## 80 x 40

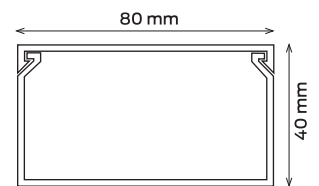

Product Code	<b>CNL-F-80040</b>	<b>CNL-C-80040</b>
Package	<b>Nylon</b>	<b>Box</b>
Length	<b>2 m</b>	<b>2 m</b>
Size	<b>80 x 40</b>	<b>80 x 40</b>
Package total (m)	<b>24 m</b>	<b>36 m</b>
Weight (kg)	<b>12.71 kg</b>	<b>19.85 kg</b>
Volume (m <sup>3</sup> )	<b>0.0499 m<sup>3</sup></b>	<b>0.1213 m<sup>3</sup></b>



# CABLE TRUNKING SYSTEMS



## 80 x 60

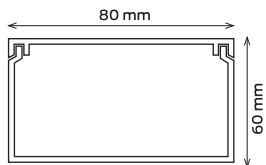

Product Code	<b>CNL-F-80060</b>	<b>CNL-C-80060</b>
Package	<b>Nylon</b>	<b>Box</b>
Length	<b>2 m</b>	<b>2 m</b>
Size	<b>80 x 60</b>	<b>80 x 60</b>
Package total (m)	<b>16 m</b>	<b>24 m</b>
Weight (kg)	<b>10.06 kg</b>	<b>15.83 kg</b>
Volume (m³)	<b>0.0460 m³</b>	<b>0.1213 m³</b>



## 100 x 40

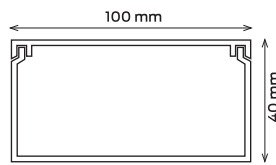

Product Code	<b>CNL-F-10040</b>	<b>CNL-C-10040</b>
Package	<b>Nylon</b>	<b>Box</b>
Length	<b>2 m</b>	<b>2 m</b>
Size	<b>100 x 40</b>	<b>100 x 40</b>
Package total (m)	<b>16 m</b>	<b>28 m</b>
Weight (kg)	<b>9.23 kg</b>	<b>16.91 kg</b>
Volume (m³)	<b>0.0422 m³</b>	<b>0.1213 m³</b>



## 100 x 60

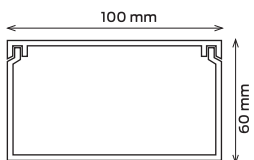

Product Code	<b>CNL-F-10060</b>	<b>CNL-C-10060</b>
Package	<b>Nylon</b>	<b>Box</b>
Length	<b>2 m</b>	<b>2 m</b>
Size	<b>100 x 60</b>	<b>100 x 60</b>
Package total (m)	<b>16 m</b>	<b>18 m</b>
Weight (kg)	<b>11.95 kg</b>	<b>14.27 kg</b>
Volume (m³)	<b>0.0556 m³</b>	<b>0.1190 m³</b>





# CABLE TRUNKING SYSTEMS ADHESIVE TYPE



## 10 x 8

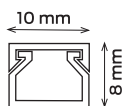

Product Code	<b>CNL-AF-10008</b>	<b>CNL-AC-10008</b>
Package	<b>Nylon</b>	<b>Box</b>
Lenght	<b>2 m</b>	<b>2 m</b>
Size	<b>10 x 8</b>	<b>10 x 8</b>
Package total (m)	<b>240 m</b>	<b>308 m</b>
Weight (kg)	<b>10.91 kg</b>	<b>14.81 kg</b>
Volume (m <sup>3</sup> )	<b>0.0315 m<sup>3</sup></b>	<b>0.0315 m<sup>3</sup></b>



## 12 x 12

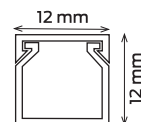

Product Code	<b>CNL-AF-12012</b>	<b>CNL-AC-12012</b>
Package	<b>Nylon</b>	<b>Box</b>
Lenght	<b>2 m</b>	<b>2 m</b>
Size	<b>12 x 12</b>	<b>12 x 12</b>
Package total (m)	<b>200 m</b>	<b>180 m</b>
Weight (kg)	<b>12.11 kg</b>	<b>11.51 kg</b>
Volume (m <sup>3</sup> )	<b>0.0368 m<sup>3</sup></b>	<b>0.0315 m<sup>3</sup></b>



## 15 x 10

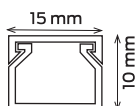

Product Code	<b>CNL-AF-15010</b>	<b>CNL-AC-15010</b>
Package	<b>Nylon</b>	<b>Box</b>
Lenght	<b>2 m</b>	<b>2 m</b>
Size	<b>15 x 10</b>	<b>15 x 10</b>
Package total (m)	<b>200 m</b>	<b>176 m</b>
Weight (kg)	<b>12.11 kg</b>	<b>11.51 kg</b>
Volume (m <sup>3</sup> )	<b>0.0391 m<sup>3</sup></b>	<b>0.0315 m<sup>3</sup></b>



## 16 x 16

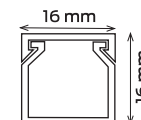

Product Code	<b>CNL-AF-16016</b>	<b>CNL-AC-16016</b>
Package	<b>Nylon</b>	<b>Box</b>
Lenght	<b>2 m</b>	<b>2 m</b>
Size	<b>16 x 16</b>	<b>16 x 16</b>
Package total (m)	<b>100 m</b>	<b>224 m</b>
Weight (kg)	<b>9.11 kg</b>	<b>21.11 kg</b>
Volume (m <sup>3</sup> )	<b>0.0326 m<sup>3</sup></b>	<b>0.0630 m<sup>3</sup></b>

# CABLE TRUNKING SYSTEMS ADHESIVE TYPE



## 20 x 10

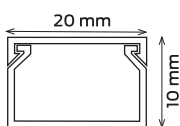

Product Code	<b>CNL-AF-20010</b>	<b>CNL-AC-20010</b>
Package	<b>Nylon</b>	<b>Box</b>
Lenght	<b>2 m</b>	<b>2 m</b>
Size	<b>20 x 10</b>	<b>20 x 10</b>
Package total (m)	<b>200 m</b>	<b>132 m</b>
Weight (kg)	<b>17.11 kg</b>	<b>12.17 kg</b>
Volume (m <sup>3</sup> )	<b>0.0538 m<sup>3</sup></b>	<b>0.0315 m<sup>3</sup></b>



## 25 x 16

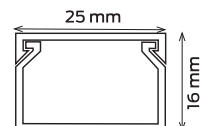

Product Code	<b>CNL-AF-25016</b>	<b>CNL-AC-25016</b>
Package	<b>Nylon</b>	<b>Box</b>
Lenght	<b>2 m</b>	<b>2 m</b>
Size	<b>25 x 16</b>	<b>25 x 16</b>
Package total (m)	<b>100 m</b>	<b>140 m</b>
Weight (kg)	<b>12.11 kg</b>	<b>17.75 kg</b>
Volume (m <sup>3</sup> )	<b>0.0486 m<sup>3</sup></b>	<b>0.0630 m<sup>3</sup></b>



## 25 x 25

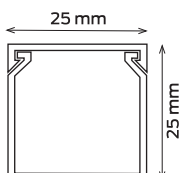

Product Code	<b>CNL-AF-25025</b>	<b>CNL-AC-25025</b>
Package	<b>Nylon</b>	<b>Box</b>
Lenght	<b>2 m</b>	<b>2 m</b>
Size	<b>25 x 25</b>	<b>25 x 25</b>
Package total (m)	<b>50 m</b>	<b>90 m</b>
Weight (kg)	<b>8.61 kg</b>	<b>16.25 kg</b>
Volume (m <sup>3</sup> )	<b>0.0368 m<sup>3</sup></b>	<b>0.0630 m<sup>3</sup></b>



## 30 x 20

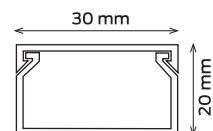

Product Code	<b>CNL-AF-30020</b>	<b>CNL-AC-30020</b>
Package	<b>Nylon</b>	<b>Box</b>
Lenght	<b>2 m</b>	<b>2 m</b>
Size	<b>30 x 20</b>	<b>30 x 20</b>
Package total (m)	<b>50 m</b>	<b>96 m</b>
Weight (kg)	<b>9.61 kg</b>	<b>16.31 kg</b>
Volume (m <sup>3</sup> )	<b>0.0372 m<sup>3</sup></b>	<b>0.0630 m<sup>3</sup></b>

# CABLE TRUNKING SYSTEMS ADHESIVE TYPE



## 40 x 16

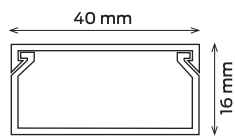

Product Code	<b>CNL-AF-40016</b>	<b>CNL-AC-40016</b>
Package	<b>Nylon</b>	<b>Box</b>
Lenght	<b>2 m</b>	<b>2 m</b>
Size	<b>40 x 16</b>	<b>40 x 16</b>
Package total (m)	<b>60 m</b>	<b>112 m</b>
Weight (kg)	<b>11.51 kg</b>	<b>22.23 kg</b>
Volume (m <sup>3</sup> )	<b>0.0530 m<sup>3</sup></b>	<b>0.0893 m<sup>3</sup></b>



## 40 x 25

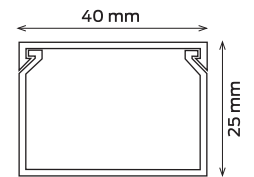

Product Code	<b>CNL-AF-40025</b>	<b>CNL-AC-40025</b>
Package	<b>Nylon</b>	<b>Box</b>
Lenght	<b>2 m</b>	<b>2 m</b>
Size	<b>40 x 25</b>	<b>40 x 25</b>
Package total (m)	<b>40 m</b>	<b>80 m</b>
Weight (kg)	<b>8.71 kg</b>	<b>17.75 kg</b>
Volume (m <sup>3</sup> )	<b>0.0488 m<sup>3</sup></b>	<b>0.0893 m<sup>3</sup></b>



## 40 x 40

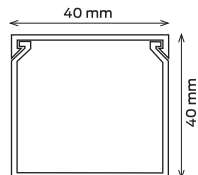

Product Code	<b>CNL-AF-40040</b>	<b>CNL-AC-40040</b>
Package	<b>Nylon</b>	<b>Box</b>
Lenght	<b>2 m</b>	<b>2 m</b>
Size	<b>40 x 40</b>	<b>40 x 40</b>
Package total (m)	<b>36 m</b>	<b>60 m</b>
Weight (kg)	<b>7.31 kg</b>	<b>18.95 kg</b>
Volume (m <sup>3</sup> )	<b>0.0381 m<sup>3</sup></b>	<b>0.1213 m<sup>3</sup></b>



## 60x40

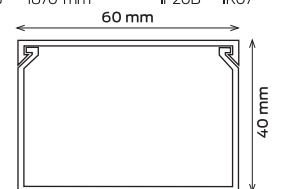

Product Code	<b>CNL-AF-60040</b>	<b>CNL-AC-60040</b>
Package	<b>Nylon</b>	<b>Box</b>
Lenght	<b>2 m</b>	<b>2 m</b>
Size	<b>60 x 40</b>	<b>60 x 40</b>
Package total (m)	<b>24 m</b>	<b>48 m</b>
Weight (kg)	<b>10.31 kg</b>	<b>21.35 kg</b>
Volume (m <sup>3</sup> )	<b>0.0381 m<sup>3</sup></b>	<b>0.1213 m<sup>3</sup></b>

# COLOR CABLE TRUNKING



## 12 x 12

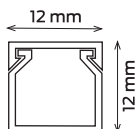

Product Code	<b>CNLF-XX-12012</b>	<b>CNLC-XX-12012</b>
Package	Nylon	Box
Length	2 m	2 m
Size	12 x 12	12 x 12
Package total (m)	50 m	180 m
Weight (kg)	3.11 kg	11.75 kg
Volume (m³)	0.0078 m³	0.0315 m³

Instead you order your pattern Code Article **XX**.



## 16 x 16

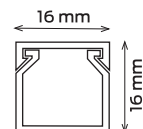

Product Code	<b>CNLF-XX-16016</b>	<b>CNLC-XX-16016</b>
Package	Nylon	Box
Length	2 m	2 m
Size	16 x 16	16 x 16
Package total (m)	60 m	224 m
Weight (kg)	5.51 kg	21.11 kg
Volume (m³)	0.0169 m³	0.0630 m³

Instead you order your pattern Code Article **XX**.



## 20 x 10

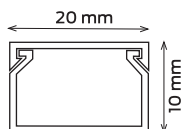

Product Code	<b>CNLF-XX-20010</b>	<b>CNLC-XX-20010</b>
Package	Nylon	Box
Length	2 m	2 m
Size	20 x 10	20 x 10
Package total (m)	80 m	144 m
Weight (kg)	6.91 kg	13.19 kg
Volume (m³)	0.0169 m³	0.0630 m³

Instead you order your pattern Code Article **XX**.



## 25 x 16

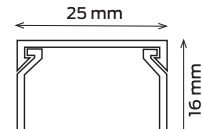

Product Code	<b>CNLF-XX-25016</b>	<b>CNLC-XX-25016</b>
Package	Nylon	Box
Length	2 m	2 m
Size	25 x 16	25 x 16
Package total (m)	60 m	140 m
Weight (kg)	7.31 kg	17.75 kg
Volume (m³)	0.0253 m³	0.0630 m³

Instead you order your pattern Code Article **XX**.



# COLOR CABLE TRUNKING

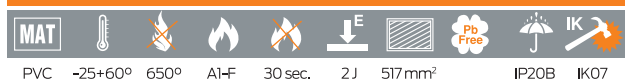

## 25 x 25

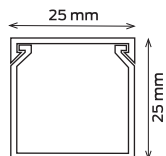

Product Code	<b>CNLF-XX-25025</b>	<b>CNLC-XX-25025</b>
Package	<b>Nylon</b>	<b>Box</b>
Length	<b>2 m</b>	<b>2 m</b>
Size	<b>25 x 25</b>	<b>25 x 25</b>
Package total (m)	<b>40 m</b>	<b>90 m</b>
Weight (kg)	<b>6.91 kg</b>	<b>16.25 kg</b>
Volume (m³)	<b>0.0253 m³</b>	<b>0.0630 m³</b>

Instead you order your pattern Code Article **XX**.



## 40 x 25

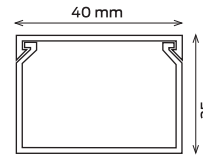

Product Code	<b>CNLF-XX-40025</b>	<b>CNLC-XX-40025</b>
Package	<b>Nylon</b>	<b>Box</b>
Length	<b>2 m</b>	<b>2 m</b>
Size	<b>40 x 25</b>	<b>40 x 25</b>
Package total (m)	<b>24 m</b>	<b>80 m</b>
Weight (kg)	<b>5.15 kg</b>	<b>17.75 kg</b>
Volume (m³)	<b>0.0253 m³</b>	<b>0.0893 m³</b>

Instead you order your pattern Code Article **XX**.



## 40 x 40

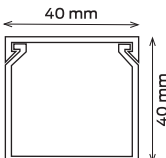

Product Code	<b>CNLF-XX-40040</b>	<b>CNLC-XX-40040</b>
Package	<b>Nylon</b>	<b>Box</b>
Length	<b>2 m</b>	<b>2 m</b>
Size	<b>40 x 40</b>	<b>40x 40</b>
Package total (m)	<b>18 m</b>	<b>72 m</b>
Weight (kg)	<b>5.51 kg</b>	<b>22.55 kg</b>
Volume (m³)	<b>0.0253 m³</b>	<b>0.1213 m³</b>

Instead you order your pattern Code Article **XX**.

## COLOR OPTIONS



# ADHESIVE COLOR CABLE TRUNKING



## 12 x 12

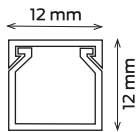

Product Code	<b>CNLAF-XX-12012</b>	<b>CNLAC-XX-12012</b>
Package	Nylon	Box
Length	2 m	2 m
Size	12 x 12	12 x 12
Package total (m)	60 m	180 m
Weight (kg)	3.71 kg	11.75 kg
Volume (m³)	0.0106 m³	0.0315 m³

Instead you order your pattern Code Article **XX**.

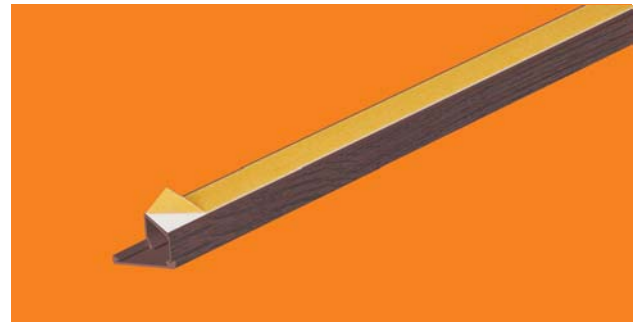

## 16 x 16

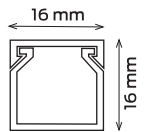

Product Code	<b>CNLAF-XX-16016</b>	<b>CNLAC-XX-16016</b>
Package	Nylon	Box
Length	2 m	2 m
Size	16 x 16	16 x 16
Package total (m)	60 m	224 m
Weight (kg)	5.51 kg	21.11 kg
Volume (m³)	0.0169 m³	0.0630 m³

Instead you order your pattern Code Article **XX**.



## 20 x 10

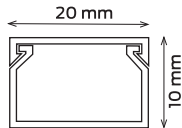

Product Code	<b>CNLAF-XX-20010</b>	<b>CNLAC-XX-20010</b>
Package	Nylon	Box
Length	2 m	2 m
Size	20 x 10	20 x 10
Package total (m)	64 m	132 m
Weight (kg)	5.55 kg	12.17 kg
Volume (m³)	0.0169 m³	0.0630 m³

Instead you order your pattern Code Article **XX**.



## 25 x 16

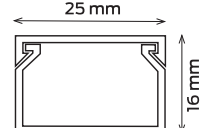

Product Code	<b>CNLAF-XX-25016</b>	<b>CNLAC-XX-25016</b>
Package	Nylon	Box
Length	2 m	2 m
Size	25 x 16	25 x 16
Package total (m)	60 m	140 m
Weight (kg)	7.31 kg	17.75 kg
Volume (m³)	0.0253 m³	0.0630 m³

Instead you order your pattern Code Article **XX**.

# ADHESIVE COLOR CABLE TRUNKING



## 25 x 25

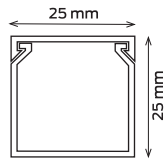

Product Code	CNLAF-XX-25025	CNLAC-XX-25025
Package	Nylon	Box
Length	2 m	2 m
Size	25 x 25	25 x 25
Package total (m)	40 m	90 m
Weight (kg)	6.91 kg	16.25 kg
Volume (m³)	0.0253 m³	0.0630 m³

Instead you order your pattern Code Article **XX**.



## 40 x 25

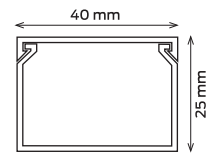

Product Code	CNLAF-XX-40025	CNLAC-XX-40025
Package	Nylon	Box
Length	2 m	2 m
Size	40 x 25	40 x 25
Package total (m)	24 m	80 m
Weight (kg)	5.15 kg	17.75 kg
Volume (m³)	0.0253 m³	0.0893 m³

Instead you order your pattern Code Article **XX**.

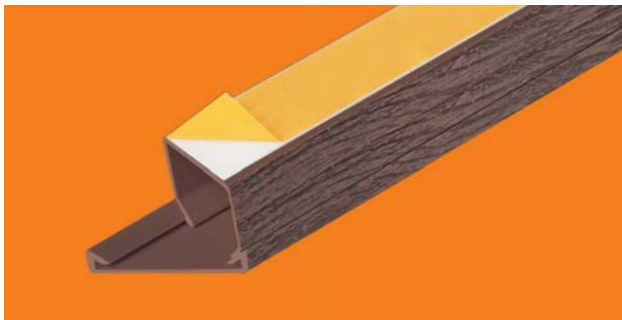

## 40 x 40

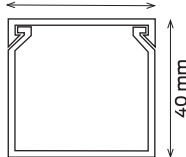

Product Code	CNLAF-XX-40040	CNLAC-XX-40040
Package	Nylon	Box
Length	2 m	2 m
Size	40 x 40	40x 40
Package total (m)	18 m	60 m
Weight (kg)	5.51 kg	18.95 kg
Volume (m³)	0.0253 m³	0.1213 m³

Instead you order your pattern Code Article **XX**.

## COLOR OPTIONS



# CABLE TRUNKING SYSTEMS

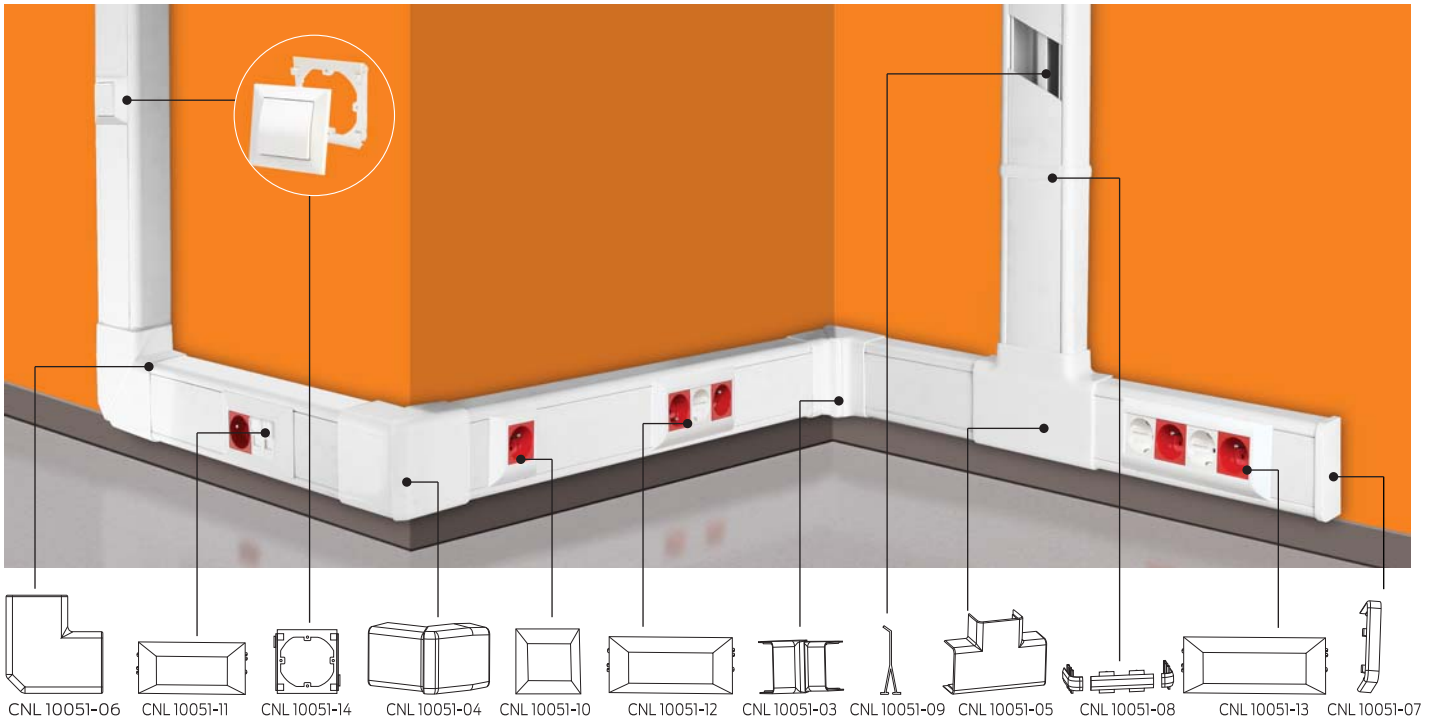

## 100 x 35

Product Code : CNL 100035 K  
 Package : Box  
 Length : 2m  
 Size : 100x35  
 Package total (m) : 20 m  
 Weight (kg) : 18 kg.  
 Volume (m3) : 0.063

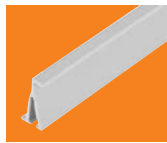

### CNL 100 51-09 DIVIDER

Length: 2m  
 Package total (m): 120m

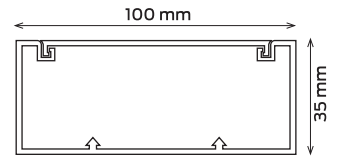

## ASSEMBLY ACCESSORIES



**CNL 10031-03**  
Internal corner  
(Adjustable)

Packaging: 8 pcs.



**CNL 10031-04**  
External corner  
(Adjustable)

Packaging: 10 pcs.



**CNL 10031-06**  
90° corner piece

Packaging: 8 pcs.



**CNL 10031-05**  
T Branches

Packaging: 8 pcs.



**CNL 10031-07**  
End cover

Packaging: 12 pcs.



**CNL 10031-08**  
Junction piece

Packaging: 24 pcs.

## SWITCH SOCKET NETWORK ASSEMBLY SETS



**CNL 10051-14**  
Socket montage set  
80x80

Packaging: 10 pcs.

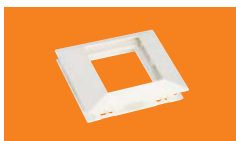

**CNL 10051-10**  
Top cover set for  
45 x 45 (1 module)

Packaging: 6 pcs.

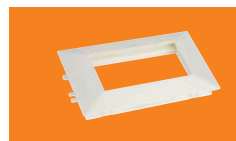

**CNL 10051-11**  
Double top cover set for  
45 x 45 (2 module)

Packaging: 12 pcs.

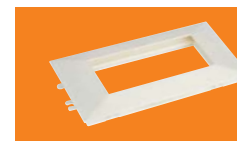

**CNL 10051-12**  
Triple top cover set for  
45 x 45 (3 module)

Packaging: 14 pcs.

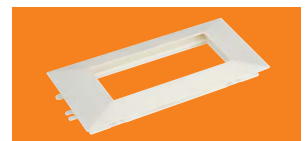

**CNL 10051-13**  
Quadruple top cover set for  
45 x 45 (4 module)

Packaging: 12 pcs.



# CABLE TRUNKING SYSTEMS

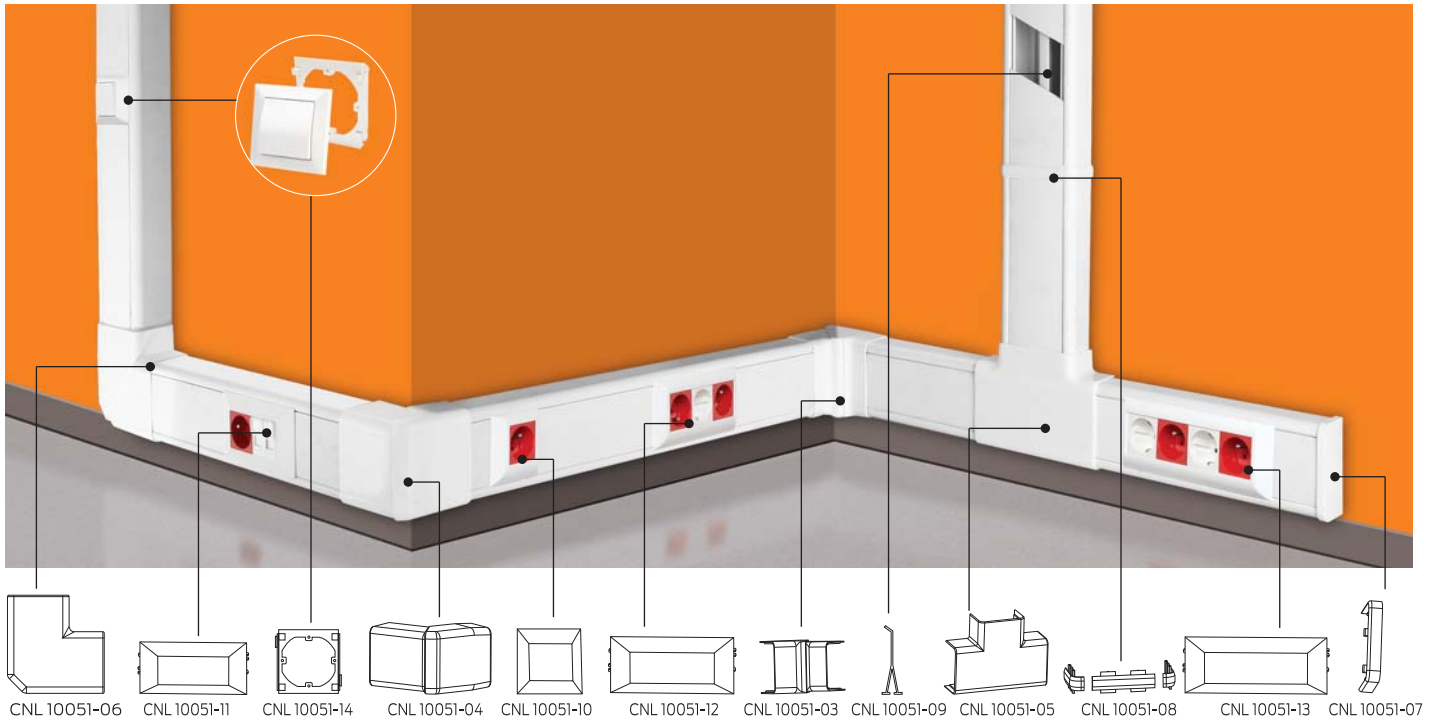

## 100 x 50

Product Code : CNL 100050 K  
 Package : Box  
 Length : 2m  
 Size : 100x50  
 Package total (m) : 16 m  
 Weight (kg) : 16.2 kg.  
 Volume (m3) : 0.063



### CNL 100 51-09 DIVIDER

Length: 2m  
 Package total (m): 120m

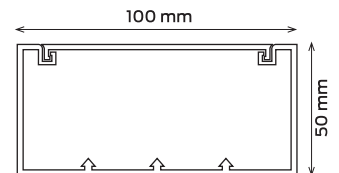

## ASSEMBLY ACCESSORIES



**CNL 10051-03**  
Internal corner  
(Adjustable)

Packaging: 8 pcs.



**CNL 10051-04**  
External corner  
(Adjustable)

Packaging: 10 pcs.



**CNL 10051-06**  
90° corner piece

Packaging: 8 pcs.



**CNL 10051-05**  
T Branches

Packaging: 8 pcs.



**CNL 10051-07**  
End cover

Packaging: 12 pcs.



**CNL 10051-08**  
Junction piece

Packaging: 24 pcs.

## SWITCH SOCKET NETWORK ASSEMBLY SETS



**CNL 10051-14**  
Socket montage set  
80x80

Packaging: 10 pcs.

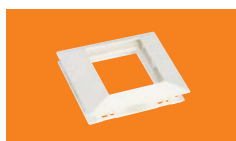

**CNL 10051-10**  
Top cover set for  
45 x 45 (1 module)

Packaging: 6 pcs.

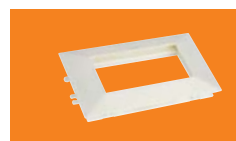

**CNL 10051-11**  
Double top cover set for  
45 x 45 (2 module)

Packaging: 12 pcs.

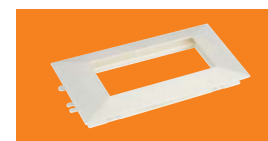

**CNL 10051-12**  
Triple top cover set for  
45 x 45 (3 module)

Packaging: 14 pcs.

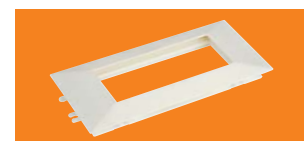

**CNL 10051-13**  
Quadruple top cover set for  
45 x 45 (4 module)

Packaging: 12 pcs.

# SLOTTED CABLE TRUNKINGS

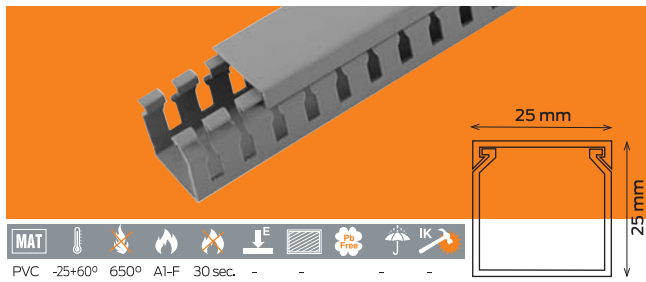

## 25 x 25

Product Code	<b>CNL-PGF-25025</b>	<b>CNL-PGC-25025</b>
Package	<b>Nylon</b>	<b>Box</b>
Lenght	<b>2 m</b>	<b>2 m</b>
Size	<b>25 x 25</b>	<b>25 x 25</b>
Package total (m)	<b>36 m</b>	<b>90 m</b>
Weight (kg)	<b>7.13 kg</b>	<b>18.50 kg</b>
Volume (m <sup>3</sup> )	<b>0.0300 m<sup>3</sup></b>	<b>0.0630 m<sup>3</sup></b>

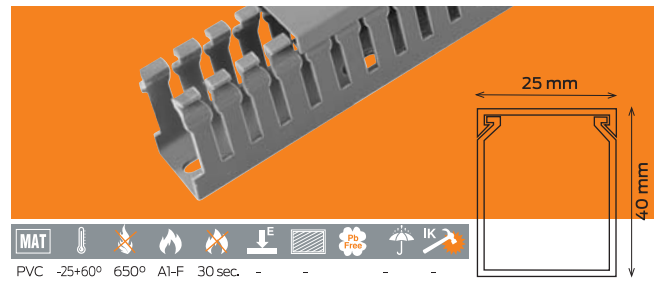

## 25 x 40

Product Code	<b>CNL-PGF-25040</b>	<b>CNL-PGC-25040</b>
Package	<b>Nylon</b>	<b>Box</b>
Lenght	<b>2 m</b>	<b>2 m</b>
Size	<b>25 x 40</b>	<b>25 x 40</b>
Package total (m)	<b>24 m</b>	<b>80 m</b>
Weight (kg)	<b>7.79 kg</b>	<b>26.55 kg</b>
Volume (m <sup>3</sup> )	<b>0.0283 m<sup>3</sup></b>	<b>0.0893 m<sup>3</sup></b>

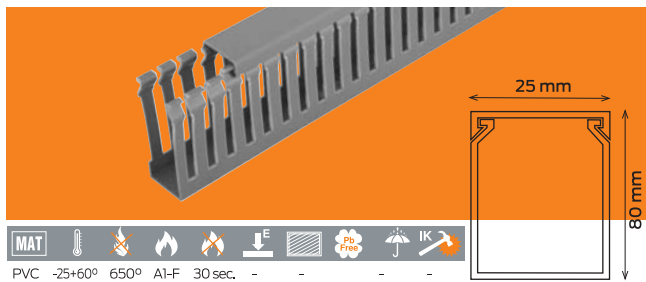

## 25 x 80

Product Code	<b>CNL-PGF-25080</b>	<b>CNL-PGC-25080</b>
Package	<b>Nylon</b>	<b>Box</b>
Lenght	<b>2 m</b>	<b>2 m</b>
Size	<b>25 x 80</b>	<b>25 x 80</b>
Package total (m)	<b>12 m</b>	<b>54 m</b>
Weight (kg)	<b>5.33 kg</b>	<b>24.44 kg</b>
Volume (m <sup>3</sup> )	<b>0.0300 m<sup>3</sup></b>	<b>0.1213 m<sup>3</sup></b>

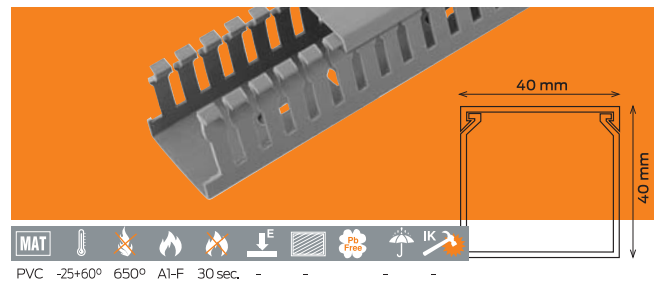

## 40 x 40

Product Code	<b>CNL-PGF-40040</b>	<b>CNL-PGC-40040</b>
Package	<b>Nylon</b>	<b>Box</b>
Lenght	<b>2 m</b>	<b>2 m</b>
Size	<b>40 x 40</b>	<b>40 x 40</b>
Package total (m)	<b>16 m</b>	<b>72 m</b>
Weight (kg)	<b>5.31 kg</b>	<b>24.35 kg</b>
Volume (m <sup>3</sup> )	<b>0.0309 m<sup>3</sup></b>	<b>0.1213 m<sup>3</sup></b>

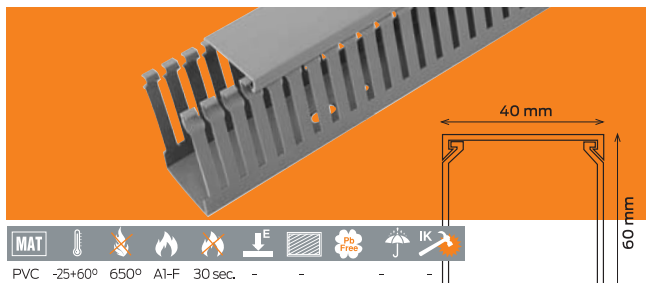

## 40 x 60

Product Code	<b>CNL-PGF-40060</b>	<b>CNL-PGC-40060</b>
Package	<b>Nylon</b>	<b>Box</b>
Lenght	<b>2 m</b>	<b>2 m</b>
Size	<b>40 x 60</b>	<b>40 x 60</b>
Package total (m)	<b>20 m</b>	<b>48 m</b>
Weight (kg)	<b>9.11 kg</b>	<b>22.55 kg</b>
Volume (m <sup>3</sup> )	<b>0.0505 m<sup>3</sup></b>	<b>0.1213 m<sup>3</sup></b>

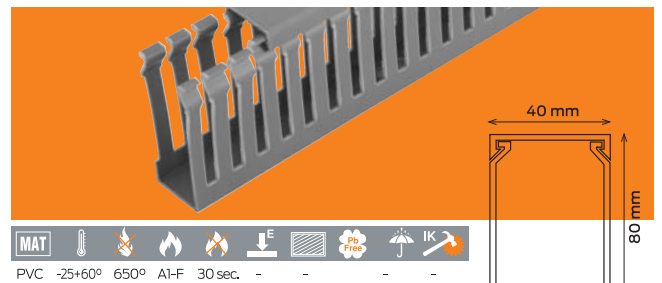

## 40 x 80

Product Code	<b>CNL-PGF-40080</b>	<b>CNL-PGC-40080</b>
Package	<b>Nylon</b>	<b>Box</b>
Lenght	<b>2 m</b>	<b>2 m</b>
Size	<b>40 x 80</b>	<b>40 x 80</b>
Package total (m)	<b>8 m</b>	<b>36 m</b>
Weight (kg)	<b>4.11 kg</b>	<b>18.95 kg</b>
Volume (m <sup>3</sup> )	<b>0.0300 m<sup>3</sup></b>	<b>0.1213 m<sup>3</sup></b>

# SLOTTED CABLE TRUNKINGS

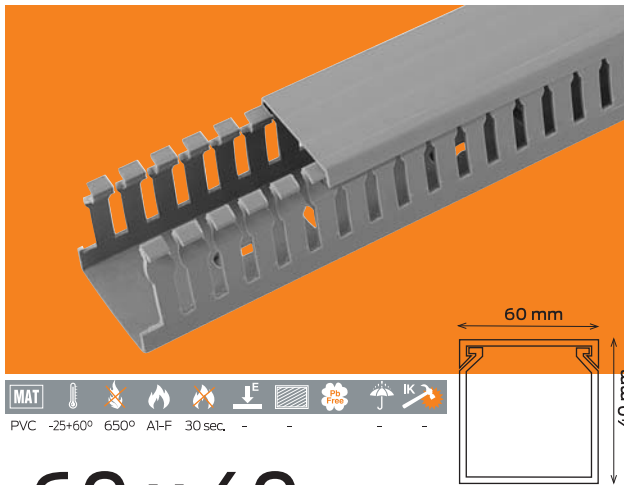

MAT PVC -25+60° 650° A1-F 30 sec. - - - - -

## 60 x 40

Product Code	CNL-PGF-60040	CNL-PGC-60040
Package	Nylon	Box
Lenght	2 m	2 m
Size	60 x 40	60 x 40
Package total (m)	20 m	48 m
Weight (kg)	8.91 kg	22.07 kg
Volume (m <sup>3</sup> )	0.0521 m <sup>3</sup>	0.1213 m <sup>3</sup>

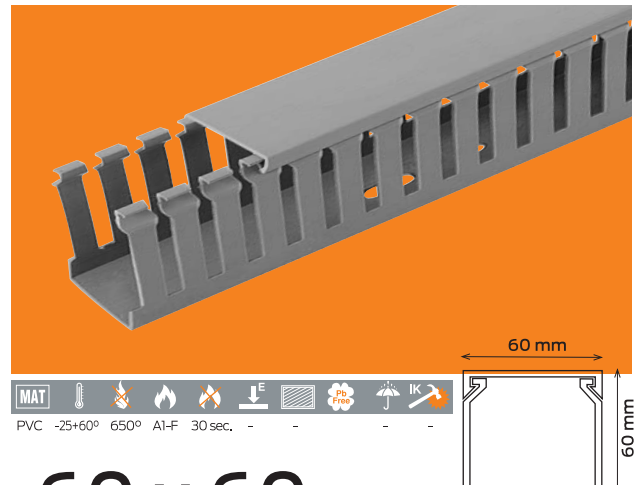

MAT PVC -25+60° 650° A1-F 30 sec. - - - - -

## 60 x 60

Product Code	CNL-PGF-60040	CNL-PGC-60040
Package	Nylon	Box
Lenght	2 m	2 m
Size	60 x 60	60 x 60
Package total (m)	20 m	32 m
Weight (kg)	5.51 kg	15.35 kg
Volume (m <sup>3</sup> )	0.0486 m <sup>3</sup>	0.1213 m <sup>3</sup>

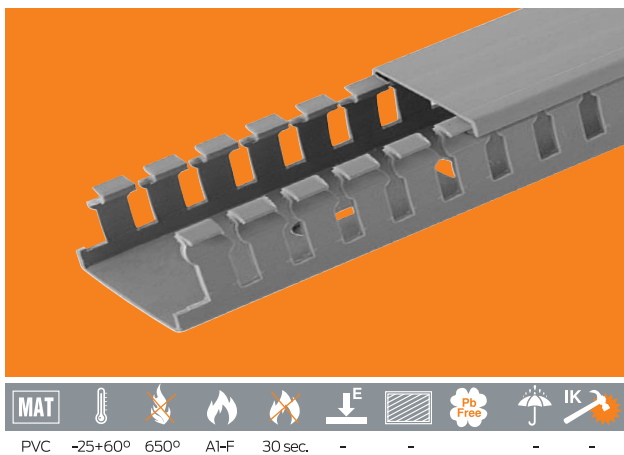

MAT PVC -25+60° 650° A1-F 30 sec. - - - - -

## 80 x 40

Product Code	CNL-PGF-80040	CNL-PGC-80040
Package	Nylon	Box
Lenght	2 m	2 m
Size	80 x 40	80 x 40
Package total (m)	12 m	36 m
Weight (kg)	6.71 kg	20.75 kg
Volume (m <sup>3</sup> )	0.0446 m <sup>3</sup>	0.1213 m <sup>3</sup>

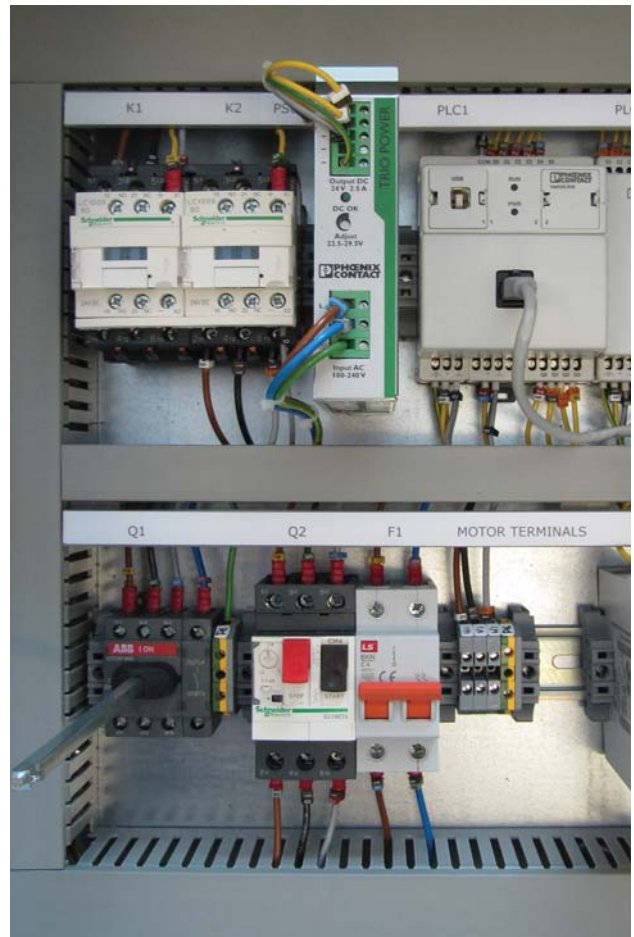

# OVERFLOOR CABLE TRUNKINGS



## 50 x 12

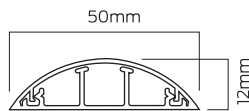

Product Code:  
**C-P-50012.X/ XX**

Product Code:  
**C-PC-50012.X/ XX**

Lenght	: 2 m	2 m
Size	: 50 x 12	50 x 12
Package total (m)	: 50 m	50 m
Package	: Nylon	Box
Weight (kg)	: 13.36 kg	14.20 kg
Volume (m <sup>3</sup> )	: 0.368 m <sup>3</sup>	0.0315 m <sup>3</sup>

Instead you order your pattern Code Article X.



## 70 x 18

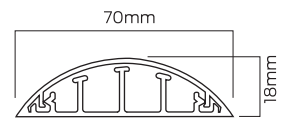

Product Code:  
**C-P-70018.X/ XX**

Product Code:  
**C-PC-70018.X/ XX**

Lenght	: 2 m	2 m
Size	: 70 x 18	70 x 18
Package total (m)	: 24 m	24 m
Package	: Nylon	Box
Weight (kg)	: 10.90 kg	11.75 kg
Volume (m <sup>3</sup> )	: 0.0452 m <sup>3</sup>	0.0340 m <sup>3</sup>

Instead you order your pattern Code Article X.





# OVERFLOOR CABLE TRUNKINGS ADHESIVE TYPE



## 50 x 12

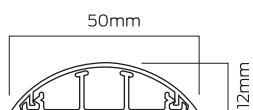

Product Code:  
**C-P-50012A.X/XX**

Product Code:  
**C-PC-50012A.X/XX**

Lenght	: 2 m	2 m
Size	: 50 x 12	50 x 12
Package total (m)	: 50 m	50 m
Package	: Nylon	Box
Weight (kg)	: 14.10 kg	14.95 kg
Volume (m <sup>3</sup> )	: 0.0394 m <sup>3</sup>	0.0315 m <sup>3</sup>

Instead you order your pattern Code Article X.

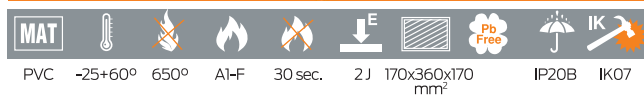

## 70 x 18

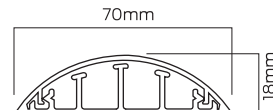

Product Code:  
**C-P-70018A.X/XX**

Product Code:  
**C-PC-70018A.X/XX**

Lenght	: 2 m	2 m
Size	: 70 x 18	70 x 18
Package total (m)	: 24 m	24 m
Package	: Nylon	Box
Weight (kg)	: 11.51 kg	12.35 kg
Volume (m <sup>3</sup> )	: 0.0481 m <sup>3</sup>	0.0315 m <sup>3</sup>

Instead you order your pattern Code Article X.

## COLOR OPTIONS

**W** White

**G** Grey

**B** Beech

**O** Oak

**M** Mahogany

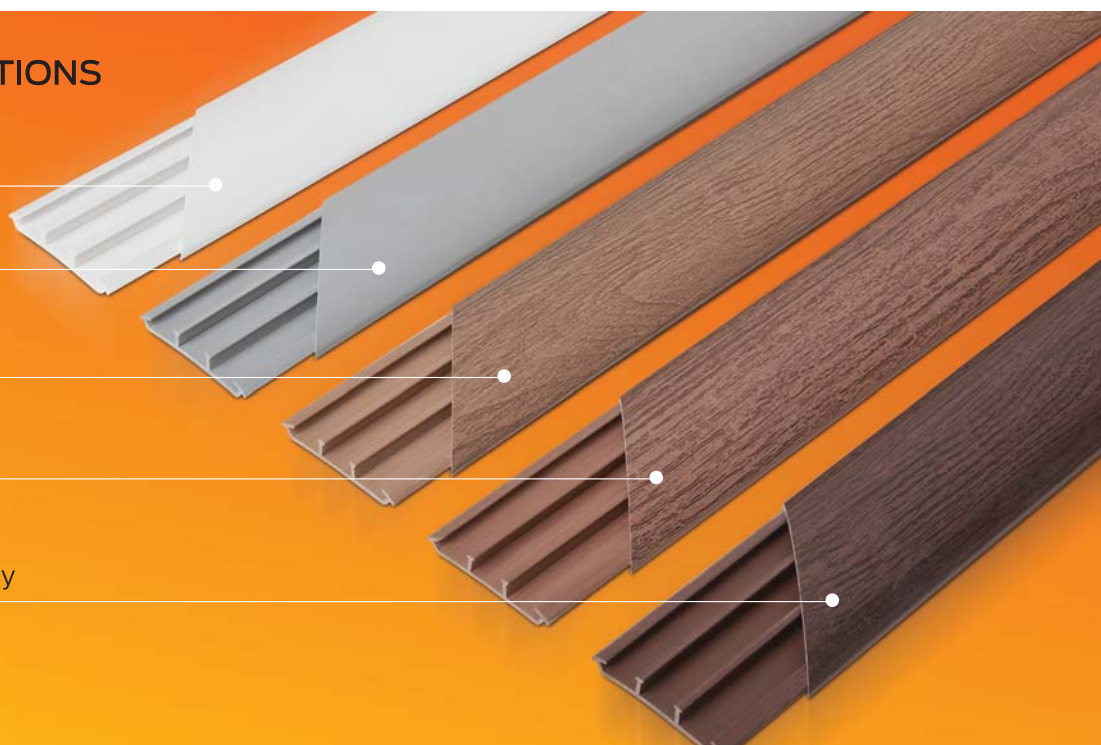

# ELECTRICAL INSTALLATION CONDUITS



## Ø 16 mm

Product Code:  
**CNLP-P16 X**

Product Code:  
**CNLP-P160 X**

Length	: 3 m	3 m
Section	: Ø 16	Ø 16
Package total (m)	: 99 m	99 m
Package	: Nylon	Nylon
Weight (kg)	: 7.650 kg	10.3 kg
Volume (m <sup>3</sup> )	: 0.033	0.033

Instead you order your pattern Code Article X.



## Ø 20 mm

Product Code:  
**CNLP-P20 X**

Product Code:  
**CNLP-P200 X**

Length	: 3 m	3 m
Section	: Ø 20	Ø 20
Package total (m)	: 99 m	99 m
Package	: Nylon	Nylon
Weight (kg)	: 9.630 kg	12.8 kg
Volume (m <sup>3</sup> )	: 0.059	0.059

Instead you order your pattern Code Article X.



## Ø 25 mm

Product Code:  
**CNLP-P25 X**

Product Code:  
**CNLP-P250 X**

Length	: 3 m	3 m
Section	: Ø 25	Ø 25
Package total (m)	: 99 m	99 m
Package	: Nylon	Nylon
Weight (kg)	: 12 kg	15.960 kg
Volume (m <sup>3</sup> )	: 0.079	0.079

Instead you order your pattern Code Article X.



### COLOR OPTIONS

**W** White

**G** Grey

**B** Black

# ELECTRICAL INSTALLATION CONDUITS



## Ø 16 mm

Product Code:  
**CNLP-PM116 X**

Product Code:  
**CNLP-PM116 X**

Lenght	: 3 m	3 m
Section	: Ø 16	Ø 16
Package total (m)	: 99 m	99 m
Package	: Nylon	Nylon
Weight (kg)	: 7.650 kg	10.3 kg
Volume (m³)	: 0.033	0.033

Instead you order your pattern Code Article X.



## Ø 20 mm

Product Code:  
**CNLP-PM220 X**

Product Code:  
**CNLP-PM220 X**

Lenght	: 3 m	3 m
Section	: Ø 20	Ø 20
Package total (m)	: 99 m	99 m
Package	: Nylon	Nylon
Weight (kg)	: 9.630 kg	12.8 kg
Volume (m³)	: 0.059	0.059

Instead you order your pattern Code Article X.



## Ø 25 mm

Product Code:  
**CNLP-PM225 X**

Product Code:  
**CNLP-PM225 X**

Lenght	: 3 m	3 m
Section	: Ø 25	Ø 25
Package total (m)	: 99 m	99 m
Package	: Nylon	Nylon
Weight (kg)	: 12 kg	15.960 kg
Volume (m³)	: 0.079	0.079

Instead you order your pattern Code Article X.





**SC ELECTRO STAR SRL**  
Saftica. Str. Biserica Sf. Troita, Nr3 Bucuresti - ROMANIA  
Tel : +40 213 130 486 • Fax : +40 213 674 945  
sales@canalux.ro • office@canalux.ro  
[www.canalux.ro](http://www.canalux.ro)